

11 5G Radio Access Technologies

11.1 General

The following subsections discuss promising radio access technologies in order to realize 5G system. The subsections contain information on the latest radio access technologies embraced in [1] or newly introduced technologies. The 5G communications system should be constructed by selecting, combining or modifying these technologies in order to make 5G systems work in each use case.

11.2 Overview of 5G radio access network

The radio access network (RAN) and aggregated backhauls support the capabilities of data transport, radio transmission and reception. In the 5G era, these capabilities shall be enhanced to accommodate massive traffic capacity and device connectivity while providing enhanced quality of user experience.

As has been mentioned in the previous chapters, '5G' communications system should serve wide range of use cases. Depending on each of these use case, range of required capabilities to radio access technologies would be extremely different. Consequently '5G' communications system should be an intrinsic and genuine-type heterogeneous network which utilizes every proper radio access technologies according to required capabilities of the use case concerned. Intrinsic and genuine-type heterogeneous network would not be a simple 'overlaid cellular networks' aiming improved communication capacity anymore but it should be a consolidated communication system consist of functional elements tailored to each of the use cases and serve them in a suitable manner.

Lots of innovative technologies mentioned in the following sub sections will be introduced to improve the performance in the system for 2020 and beyond. Some of these technologies are illustrated in Fig. 11.2-1 [1].

It should be noted that the figure below illustrates candidate radio access technologies of '5G' and subject to further refinement.

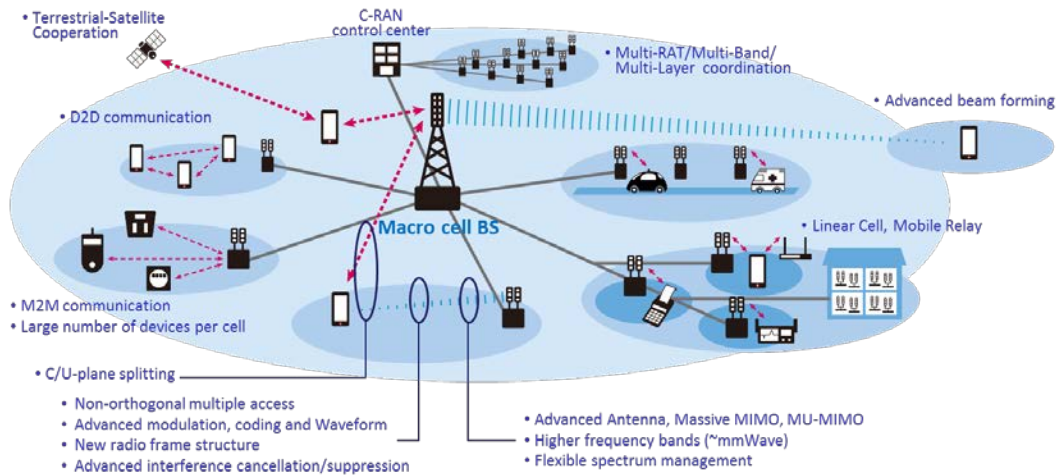

Fig. 11.2-1 Overview of '5G' RAN technologies

11.3 RAN related technical works update

11.3.1 General

Initial technical investigations were made in [1]. Since then, enormous progress has been made to consolidate '5G' RAN systems. The following sub sections describe some of the related technical achievements.

Note: The following sub sections do not intend to give an exhaustive list of technologies that will be used in a '5G' RAN system and their contents would further be reviewed considering the future study outcomes.

11.3.2 Information of technical works related to modulation or coding scheme

(1). OFDM-SSB-QAM [2][3][4][5][6]

This method belongs to orthogonal multiple modulation/ demodulation technologies, which is based on the analytic frequency form using the Hilbert transform. While the current OFDM uses DSB (double side band) carriers, this method uses a SSB (single side band) which separates one DSB into two of SSB carriers, so that the spectral efficiency is twice that of LTE/OFDM.

The schematic diagram below shows the principle of the technology (spectral structure) comparing OFDM and OFDM-SSB-QAM:

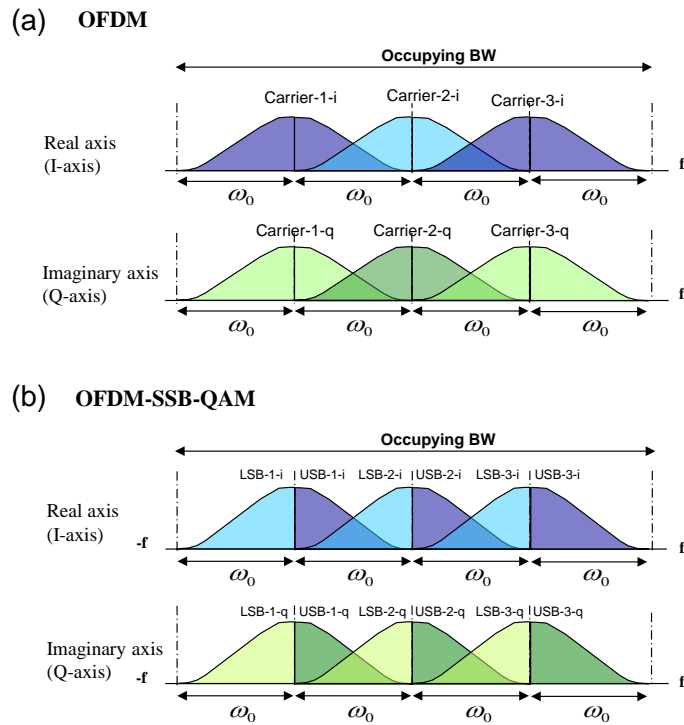

Fig. 11.3-1 Spectral structure of OFDM and OFDM-SSB-QAM

Architecture of the modulation & demodulation parts per partial block of one element (for four SSB carriers) are shown below. The inventive step is that local signals for quadrature demodulation are formed as SSB elements.

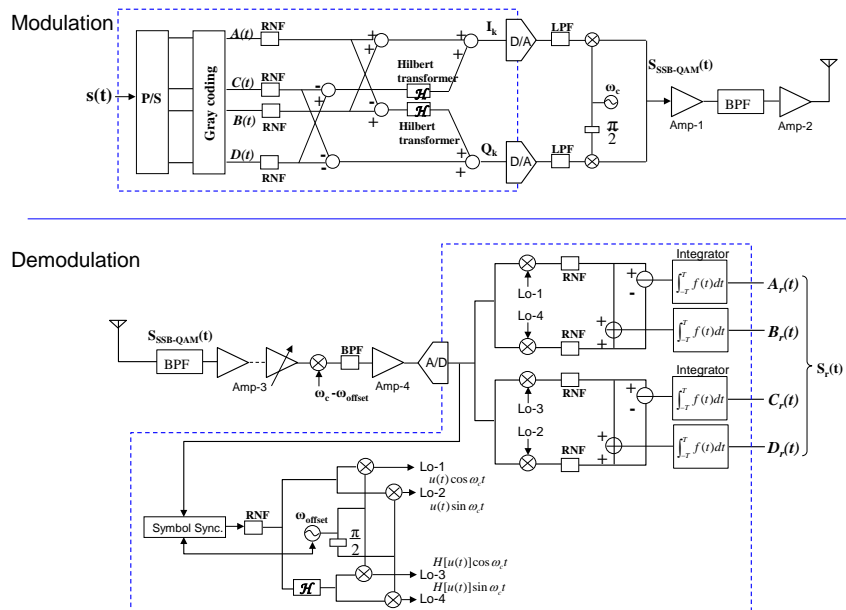

Fig. 11.3-2 Architecture of OFDM-SSB-QAM modulator and demodulator

SSB forming is carried out using a forming data table. Generating multicarrier and integration of demodulation are carried out using FFTs. These elements are very common in LTE/OFDM systems.

- The technology would be useful when applied to : eMBB
- Expected performance/features when applied:

This method not only provides double the spectral efficiency of LTE, but also takes over the whole access function built by LTE. Furthermore, this method is signal-processed in the baseband part closely, so that the spatial multiplication technologies; MIMO or NOMA can be adopted easily.

- Preconditions when applied:

SSB is said to be weak against frequency fluctuations like the Doppler shift effect, but its tolerance is the same when compared to OFDM. This solution method has the frequency synchronization as OFDM, as well.

Because both OFDM and this method are multicarrier systems, it is suitable to adopt this transformation into SC-FDMA when using millimeter wave bands.

(2). Time and frequency localized single carrier technology [7][8]

Insertion of zeros or a static sequence before DFT operation in DFT-s-OFDM can reduce out of band emission compared with the conventional DFT-s-OFDM. Fig. 11.3-3 shows a comparison between DFT-s-OFDM and DFT-s-OFDM with zero or static sequence. Fig. 11.3-4 demonstrates out of band suppression performance of DFT-s-OFDM with zero or static sequence. Maintaining the low peak to average power ratio of SC-FDMA, which is the standardized uplink waveform in LTE, the aforementioned technologies can reduce out of band emission compared to DFT-s-OFDM waveforms. The inserted zeros or static sequence can be used as a cyclic prefix, providing robustness against frequency selectivity in channels.

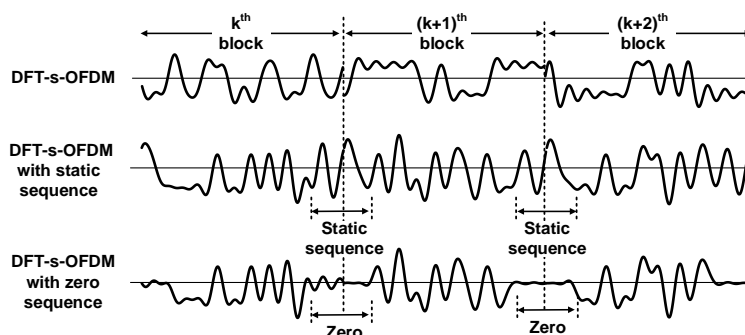

Fig. 11.3-3 DFT-s-OFDM with zero or static sequence insertion

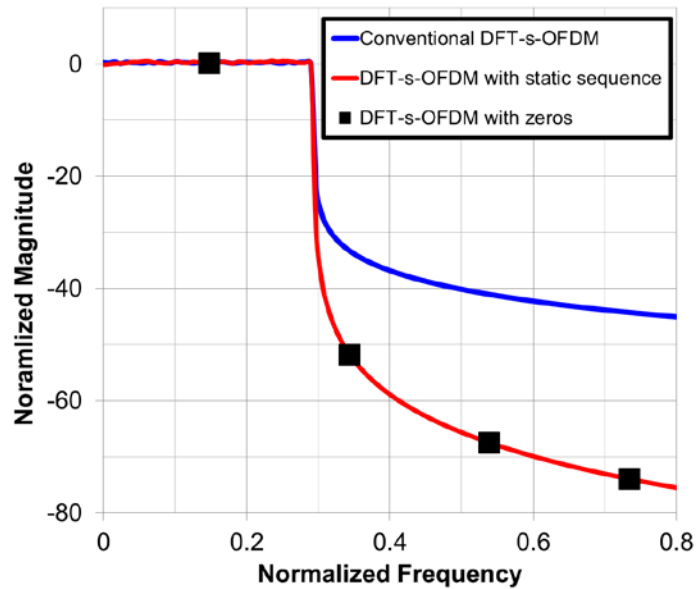

Fig. 11.3-4 Out of band suppression performance

- The technology would be useful when applied to : eMBB, mMTC, URLLC

Waveform technologies with flexible numerology are in demand. In millimeter and centimeter bands, waveforms with low PAPR are in demand to expand coverage without increasing linear region of a power amplifier. Both the number of connected devices and the frequency of asynchronous access are expected to increase due to the emergence of IoT applications. Out-of-band suppression to provide robustness against asynchronous access is also one of the key requirements for a 5G system.

- Expected performance/features when applied:

Low PAPR, low out-of-band emission, coverage expansion, saving cost for amplifiers •

- Preconditions when applied:

Limited backoff, asynchronous access from UEs, coverage expansion for downlink and uplink.

(3). Filtered-OFDM (f-OFDM) [9][10][11][12]

f-OFDM can achieve desirable frequency localization while enjoying the benefits of CP-OFDM. This is attained by allowing the filter length to exceed the CP length of OFDM and designing the filter appropriately. Figure 3 of Ref. [11] (see Fig. 11.3-5) shows the baseband impulse response of the designed filter with bandwidth equal to 3 RBs. It can be seen that the main energy of the filter is confined within the CP length, and thus, its induced ISI is very limited.

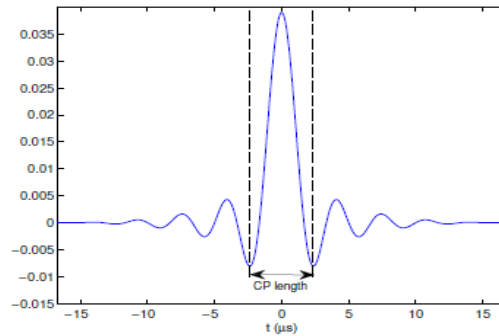

Fig. 11.3-5 Impulse response of the designed filter for f-OFDM with bandwidth equal to 3 RBs

- The technology would be useful when applied to : eMBB, URLLC, mMTC:

The f-OFDM scheme is widely applicable to diverse usage scenarios which are carried out through the conventional OFDM channel, with negligible ISI/ICI degradation impact. In addition, spectrum resources can be flexibly grouped on the f-OFDM resource block domain depending upon the traffic profile and the loading. That can be realized by the optimal radio parameters arrangement, which is suitable for the requirement of the associated application scenario.
- Expected performance/features when applied:

Because of the narrower strict band shaping of f-OFDM spectrum, additional sub-carriers can be allocated in the guard-band between two adjacent carrier bands on top of the conventional OFDM. This is beneficial in order to gain more spectrum efficiency and system capacity. filtered-OFDM supports diverse numerology, multiple access schemes, and frame structures based on the application scenarios and service requirements simultaneously. It allows co-existence of different signal components with different OFDM primitives. For example, three sub-band filters are used to create OFDM subcarrier groupings with three different inter-sub-carrier spacing, the OFDM symbol durations, and the guard times. By enabling multiple parameter configurations, f-OFDM is able to provide more optimum parameter numerology choice for each service group and hence better overall system efficiency.

Furthermore on the f-OFDM domain, the sliced sub-carrier resource blocks can be optimally allocated for the associated application devices in combination with the SCMA. Owing to the non-orthogonal coding scheme of SCMA, the scale of multiplexing access number can be enlarged significantly in low latency radio channel, while allowing grant-Free access connections.

- Preconditions when applied:

The f-OFDM is applicable frequency and deployment scenarios agnostically. Since f-OFDM has OFDM as its core waveform, it enjoys the desirable properties of OFDM while enabling immediate application of all existing OFDM-based designs. For instance, f-OFDM is MIMO-friendly and also its PAPR can be easily reduced using DFT precoding as in DFT-S-OFDM.

Also, “asynchronous” multiple access is possible with the proposed “filtered orthogonal frequency division multiple access (f-OFDMA)” / “filtered discrete-Fourier transform-spread OFDMA (f-DFT-S-OFDMA)”, which uses the spectrum shaping filter at each transmitter for side lobe leakage elimination, and a bank of filters at the receiver for inter-user interference rejection.

(4). Polar code [13][14][15][16][17][18][19][20][21][22][23][24][25][26][27][28][29]

Polar code achieves very good channel quality and capacity with a simple encoder and a simple successive cancellation (SC) decoder even in cases where the code block size is larger. Polar codes have engendered significant interest and a lot of research has been done on code design and decoding algorithms. One of the most important decoding algorithms is SC-list decoding which can perform as well as an optimal maximum-likelihood (ML) decoding with an appropriate list size for moderate code block sizes.

- The technology would be useful when applied to : eMBB, URLLC, mMTC:

Polar coding is applicable to the 3 scenarios including eMBB, mMTC and uRLLC for providing better channel quality and reliability. The polar coding is effective and applied to both long bit service and short bit service data packets.

- Expected performance/features when applied:

Performance simulation have shown that Polar codes concatenated with cyclic redundancy codes (CRC) and an adaptive SC-list decoder can outperform turbo/LDPC (Low Density Parity Check) codes for short and moderate code block sizes. Polar code has better performance than the other codes currently used in the 4G LTE system, especially for short code lengths, thus it is considered as a desirable candidate for the FEC (Forward error correction) module in 5G air interface design.

Following effects can be also expected:

- For small packet (e.g. IoT, control channel), Polar Codes have 0.5-2dB gain comparing with Turbo Code used in LTE. (Page 14 of Ref.[14])
- No error floor, suitable for ultra-reliable transmission

- Low energy consumption
- Preconditions when applied:

Polar code is an innovative FEC scheme to improve radio channel reliability. It is applicable and more effective to be combined with other radio channel technologies of new waveforms, multiplex access scheme, access protocols, frame structure, etc. in frequency agnostic.

11.3.3 Information of technical works related to multiple access scheme, duplex scheme

(1). Sparse Code Multiple Access (SCMA) [30][31][32][33][34][35][36][37][38]

SCMA is introduced as a new multiple access scheme. In SCMA, different incoming data streams are directly mapped to codewords of different multi-dimensional cookbooks, where each codeword represents a spread transmission layer. Since the multiple SCMA layers are not fully separated in a non-orthogonal multiple access system, a non-linear receiver is required to detect the intended layers of every user. The sparsity of SCMA codewords takes advantage of the low complexity message passing algorithm (MPA) detector which achieves ML-like performance.

Additional technical information is available in [39], [40], [41], [42], [43] and [44].

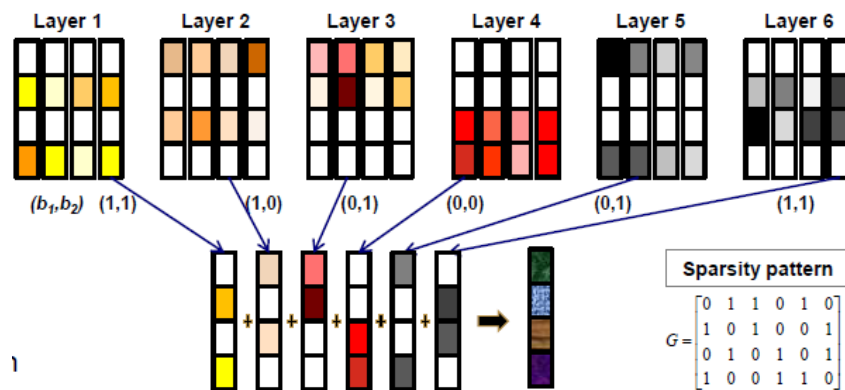

Codebook:

Each Layer corresponds to a unique codebook

Sparsity:

Limit the complexity of detection

Multi-dimensional Codeword:

Shaping gain for better efficiency

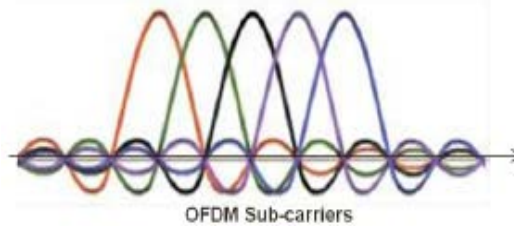

Overlaid codewords with code domain resource sharing
 Fig. 11.3-6 SCMA codebook mapping, encoding, and multiplexing

- The technology would be useful when applied to : eMBB, mMTC, URLLC

Massive connections with user devices become available via SCMA introduction. Long and short burst data packets on the devices are carried smoothly. It is also beneficial to achieve higher data throughput, compared with conventional OFDMA, under the same level of channel resource utilization with a smaller packet drop rate in small latency processing. (Ref.[36][37][38])

- Expected performance/features when applied:

Following improvements are expected compared with OFDMA:

- Multiplexing gain for massive connections.
- Grant-free multiple access that eliminates the dynamic request and grant signaling overhead, which is an attractive solution for small packets transmission in low latency connection.
- Robust with lower packet drop late, better BLER in link budget, higher throughput in loaded conditions.
- Some adaptive parameters can compromise among spectral efficiency, coverage, detection complexity, connectivity, and link budget, to adapt to different application scenarios.
- Preconditions when applied:

The SCMA scheme is theoretically applicable in frequency and deployment scenarios agnostically. User multiplexing can be realized without the need for full knowledge information of users' instantaneous channels. The spectrum efficiency is further enhanced if SCMA is used in conjunction with f-OFDM.

(2). Non-orthogonal multiple access (NOMA) [45][46]

In non-orthogonal multiple access (NOMA) with advanced receiver, multiple users can use the same time and frequency resource. In downlink NOMA, a base station multiplexes signals for users in power domain. In uplink NOMA, which is grant free

access or scheduled access, multiple users' signals are spatially multiplexed at the base station.

- The technology would be useful when applied to : mMTC:

NOMA can increase the number of users who simultaneously transmit or receive data at the same resource.

- Expected performance/features when applied:

This technique can improve spectral efficiency since more users can transmit or receive data at the same resource compared to orthogonal multiple access, e.g. OFDMA or SC-FDMA. The number of users, which transmit or receive data simultaneously, also increases. As a result, a base station with NOMA can accommodate more users than orthogonal multiple access.

- Preconditions when applied

NOMA is suitable for the environment of massive users in both cases of grant free access and scheduled access. Grant free access causes NOMA interference which occurs statistically depending on the number of users and traffic condition and so on. However, the interference can be suppressed or canceled by advanced receiver (e.g., iterative canceller). In scheduled access, a base station can adequately select non-orthogonally multiplexed users based on their channel conditions if the base station accommodates massive users. NOMA may not be limited by the particular frequency band, but may be suitable for below 6GHz.

(3). Space Division Full Duplex [47]

Full duplex or STR (Simultaneous transmission and reception) is extremely challenging since very large TX/RX isolation is required. Space division full duplex utilizes spatially separated small transmission points (STPs) alongside with macro transmission points (MTPs). While the MTP serves DL to one or some terminals, the STP serves UL to other terminals, or vice versa simultaneously. MTP and/or STP may employ adaptive beamforming and successive interference cancellation (SIC) in order to reduce interference to acceptable level for receiving operation. Smart algorithms have to be developed since the selection of combination of STPs and terminals being served will have impact on the system performance.

- The technology would be useful when applied to : eMBB
- Expected performance/features when applied:

Following improvements are expected compared with OFDMA:

Ideally, cell capacity will increase by the factor of 2 compared to conventional duplex scheme.

- Preconditions when applied:

C-RAN (Centralized Radio Access Network) scenario in order to coordinate STPs.

11.3.4 Information of technical works related to MIMO or multiple antenna technologies

(1). Nonlinear Multi-User MIMO [48][49]

The linear precoding (LP) scheme is a general method for MU-MIMO. However, since most of the spatial resources at the BS are consumed to direct nulls, we cannot expect extra TX diversity.

On the other hand, nonlinear precoding (NLP) is a strategy realizing an inter user interference (IUI)-free DL transmission by canceling IUI observed by users in advance.

In NLP, user hierarchization is mandatory for practical IUI-precancellation (PC). Block triangulation (BT) is a hierarchization scheme which creates the system channel matrix as shown below:

Stream	1	2	3	4	5
1	$H_1 B_1$	O	O	O	O
2	$H_2 B_1$	$H_2 B_2$	O	O	O
3	$H_3 B_1$	$H_3 B_2$	$H_3 B_3$	O	O
4	$H_4 B_1$	$H_4 B_2$	$H_4 B_3$	$H_4 B_4$	O
5	$H_5 B_1$	$H_5 B_2$	$H_5 B_3$	$H_5 B_4$	$H_5 B_5$

Fig. 11.3-7 System channel matrix for nonlinear MU-MIMO

where H_i is channel matrix and B_i is the precoding vector for user i , enabling the IUI to be successively canceled.

The concept of NLP is illustrated in the following figure.

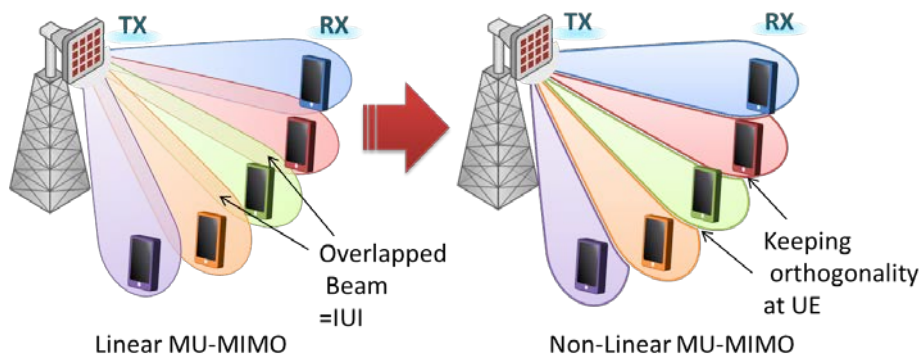

Fig. 11.3-8 Concept of Nonlinear precoding

- The technology would be useful when applied to : eMBB, URLLC
- Expected performance/features when applied:

Because this technology can decrease the dependency of throughput on user location, the system stability can be enhanced. Especially, the data rate of “near users” can be improved

- Preconditions when applied:

Dense BS deployment and cluster user distribution is assumed. High data rate system using simultaneous many-beams transmission, such as massive-MIMO, will be suitable.

(2). Multi-User (MU) MIMO with non-linear precoding, and massive MIMO [50][51][52]

MU-MIMO is an advanced antenna technology to improve spectrum efficiency by increasing the maximum throughput of multiple users on the cell with the limited resources of spectrum. In an experimental trial of MU-MIMO with downlink massive MIMO, a remarkable gain was verified by means of the RF channel calibration, dynamic UE selection scheduling, and non-linear precoding scheme employed in TDD reciprocity channel.

- The technology would be useful when applied to : eMBB:

In various scenarios of mobile broadband (MBB) services, higher throughput and higher spectrum efficiency are desired for wireless broadband applications such as data transfer utility and video services for multiple user terminals simultaneously in a cell coverage area.

- Expected performance/features when applied:

Following gains can be obtained by the MU-MIMO introduction:

- Spectrum efficiency
- Cell throughput, Cell capacity
- User device throughput

- Preconditions when applied:

Outdoor experimental trial was executed with following radio arrangement (Ref.[50]) and [51]):

- 64 Tx antenna in BS
- 24 UEs, with 2 Rx antenna per UE
- THP based non-linear precoding /EZF based liner precoding
- 2.3GHz band TDD, BW = 20MHz

44 bps/Hz was achieved with non-linear precoding scheme. (Fig.2 of Ref.[51])

In another trial of 73GHz mmWave MU-MIMO live demo, 20Gbps data rate was

achieved to individual user. (Ref.[52]) The MU-MIMO is frequency diagnostic.

(3). Subarray Type Massive MIMO [53][54][55]

Massive MIMO is an effective approach for using higher spectrum because it can compensate for the large propagation loss in high frequency bands. However massive-MIMO needs many digital and analog components, resulting in higher costs and large energy consumption.

Hybrid beamforming is superior solution for reducing the complexity. Especially subarray type massive MIMO (see remarks) achieves two features, decreasing the number of digital and analog components, and superior transmit performance.

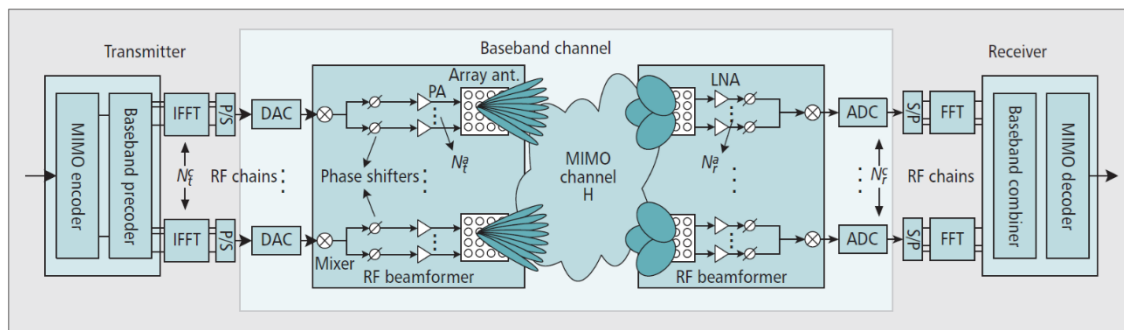

Figure 2. Block diagram of a hybrid beamforming architecture.

Fig. 11.3-9 Block diagram of a hybrid beamforming architecture

- The technology would be useful when applied to : eMBB:

In various scenarios of mobile broadband (MBB) services, higher throughput and higher spectrum efficiency are desired for wireless broadband applications such as data transfer utility and video services for multiple user terminals simultaneously in a cell coverage area.

- Expected performance/features when applied:

1. Limiting the number of digital (ADC and DAC) and analog components while also decreasing performance degradation, thus manufacturing cost and power consumption will decrease overall.

2. Realizing high-speed transmission in line of sight environments using multiple beams for one UE. Subarray type configuration takes advantage of the feature of low correlation among the subarrays.

- Preconditions when applied:

Radio frequency is above 6GHz because of limited space for mounting antenna elements, and lower frequency selectivity.

(4). Millimeter-wave beam multiplexing using inter-subarray coding [56]

The size of antennas with massive number of elements becomes reasonable range for millimeter-wave. However, in practical terms, since the same number of base-band processing as that of antenna elements would be required, equipment size and power consumption will increase. Hybrid beamforming is proposed in which leaves signal processing partially in the analog domain. When a sub-array configuration is used in the analog domain, the gain of each sub-array is limited and either sidelobe or obtainable beam width causes interference between the beams. The technique of inter-subarray coding enables generating non-interfering high gain beams which is suitable for massive MU-MIMO operation in millimeter wave.

- The technology would be useful when applied to : eMBB:
- Expected performance/features when applied:
Similar to full MIMO operation by reduced signal processing load.
- Preconditions when applied:
Millimeter wave where the size of antennas with massive number of elements becomes reasonable.

11.3.5 Information of technical works related to RAN deployment or its control schemes

(1). Beam based cell change procedure [57]

For the cell change, a UE measures a signal level/quality of each beam of surrounding base stations and reports the results to a macro cell. A selected base station uses several beams in addition to a selected beam for receiving access signal from the UE.

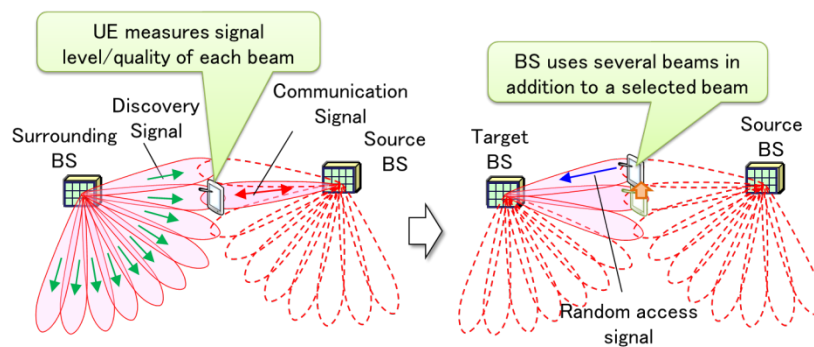

Fig. 11.3-10 Beam based cell change procedure

- The technology would be useful when applied to : eMBB:
- Expected performance/features when applied:
Fast and robust cell change.

- Preconditions when applied:
Dual connectivity.

(2). Linear Cellularization [58][59]

High-mobility scenarios related to land-mobile communications such as railways will generally should have service areas that are covered linearly. Although antennas placed alongside the road or track should direct high-gain beams to cover longer area especially in high-SHF or EHF bands, cellularization per antenna needs frequent handovers and to reuse several radio frequencies.

Linear cellularization, where we can virtually form a long linear cell by linearly-distributed antennas at an identical radio frequency tagged with the same cell ID, is one efficient solution for high-mobility scenarios. Longer cell range yields less handovers and less reuse radio frequencies, resulting in higher spectral efficiency user throughput and group mobility. In addition to fixed-beam antennas, massive antennas, spatial multiplexing and beam tracking can also be utilized over the linear cells, and they can bring further expansion in throughput and capacity to the high-mobility users.

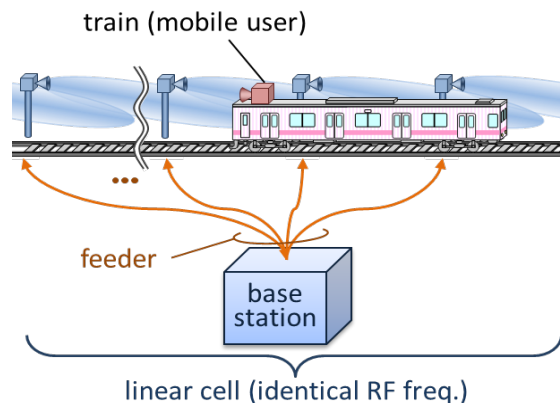

Fig. 11.3-11 Concept of linear cellularization

- The technology would be useful when applied to : eMBB, URLLC
- Expected performance/features when applied:

This technology can reduce handovers across cells and radio frequencies to form the entire service area. Therefore, it brings higher user throughput as well as simplification of system designing including radio frequency assignment.

- Preconditions when applied:

The technology is premised on linear and long area to be served, such as railway and highway, where antennas are placed alongside the area. High-mobility users such as trains and buses move in the same or opposite direction on the linear area.

(3). Throughput maximizing resource allocation for terminals with different QoS [60]

The channel aware resource allocation technique for terminals with different QoS can be achieved when resources are first allocated to terminals with low QoS constrains (e.g., best effort traffic in eMBB use case) taking into account a throughput/fairness trade-off. This is followed by assigning resources for tighter QoS constraints (e.g., delay-constraint traffic in URLLC use case) in order to satisfy QoS constraints (e.g., delay constraints). Allocating resources to terminals with tight QoS constraints after terminals with low QoS constraints is more efficient than allocating these terminals in priority (state-of-the-art approach) since the impact on the throughput of terminals with low QoS constraints can be assessed.

For example, a delay-constrained traffic scheduler can be converted into an online packet-oriented scheduler. This further allows for combining the resource gain metric with a resource preemption cost. Thus, the delay constraints are satisfied and the best effort throughput can be maximized while keeping an equal fairness before and after preemption.

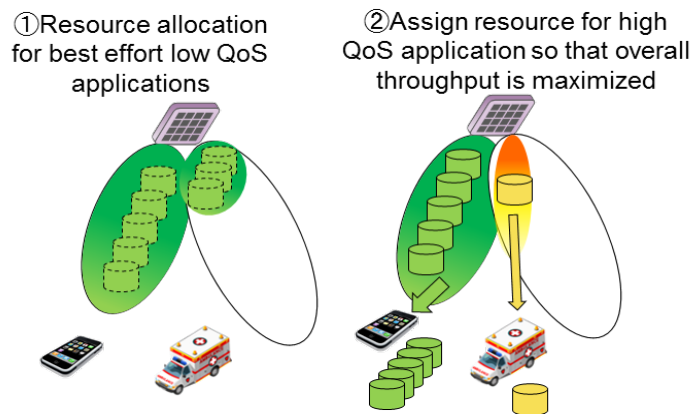

Fig. 11.3-12 Proposed scheduling algorithm

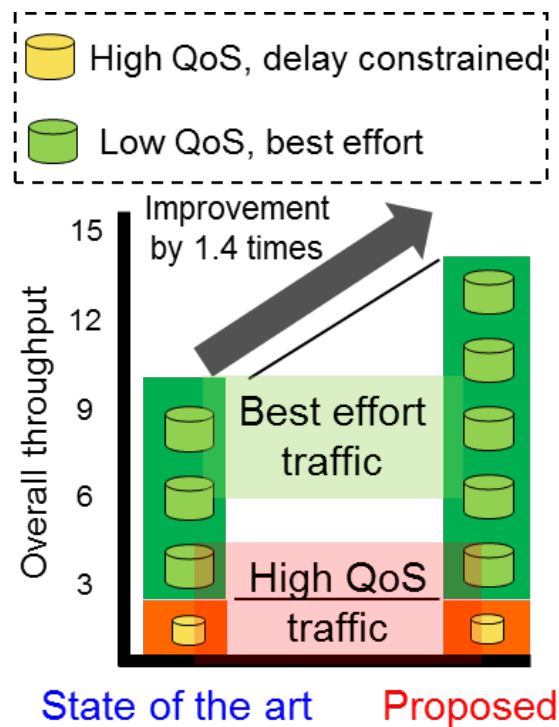

Fig. 11.3-13 A comparison of throughput gain, 70kbps assumed for delayed constrained high QoS applications, number of terminals for delay constrained and best effort applications is assumed to be 30 each

- The technology would be useful when applied to : eMBB, URLLC
- Expected performance/features when applied:

Thanks to fair resource allocation, QoS constraints are satisfied while higher throughput for users with low QoS constraints than in state-of-the-art approaches is achieved for a same fairness level between users with low QoS constrains. This fairness level can be set according to the needs.

- Preconditions when applied:

Terminals with different QoS constrains (e.g., best-effort traffic and delay-constraint traffic) must use same frequency band. A joint resource allocation is needed.

(4). Ultra High-Density Distributed Smart Antenna Systems [61]

In order to increase area traffic capacity, which is one of new KPIs of 5G, cell size has to be reduced. However, due to sever interference, achievable area traffic capacity is limited unless sophisticated, coordinated resource allocation technology is employed. In Ultra High-Density Distributed Smart Antenna Systems, transmission points are

densely deployed and terminals will connect to the transmission points that can provide best transmission performance. Radio resource that is used by numbers of transmission points in the area is adaptively and coordinately controlled so that high throughput is achieved for terminals that are simultaneously transmitting data while avoiding interference between them. Beamforming technology may be employed at each transmission point or by coordinating multiple transmission points.

- The technology would be useful when applied to : eMBB

- Expected performance/features when applied:

Three times compared to 4G system with coordinated resource control.

- Preconditions when applied:

RAN (Centralized Radio Access Network) scenario is considered where numbers of transmission points are controlled by C-BBU (Centralized-Base Band Unit).

In order to effectively distribute transmission points, they have to be flexibly configurable and small size. Low SHF band (<6GHz) is considered in experiment and early deployment phase but the technology can be applicable in frequency bands above 6GHz.

(5). System control technologies with wireless LAN in multi-band and multi-access layered cells [62][63][64]

Combining heterogeneous wireless networks that cross licensed and unlicensed spectra is a promising way of supporting surges in mobile traffic. The unlicensed band is mostly used by wireless LAN (WLAN) nodes which employ carrier sense multiple access with collision avoidance (CSMA/CA). Since the number of WLAN devices and their traffic is increasing, the wireless resource of the unlicensed band is expected to become more depleted in 2020s. In such a wireless environment, the throughput could be extremely low and unstable due to the hidden terminal problem and exposed terminal problem. To solve this problem, one new channel access acquisition mechanism for systems control technologies in multi-band and multi-access layered cells is proposed [62][63][64]. This mechanism significantly reduces the impact of the hidden terminal problem in the unlicensed band by using licensed channel access. The information on the user data waiting at the transmitter is notified by using a licensed spectrum channel, so that the receiver under the hidden terminal problem can send a data request frame using an unlicensed spectrum channel and efficiently get data reception opportunities.

- The technology would be useful when applied to : eMBB

Application: High-throughput applications such as HD movies.

Location: High-density area such as stadium, shopping mall.

- Expected performance/features when applied:
Higher capacity in high-density cells.
- Preconditions when applied:
Multi-band and multi-access layered cells.

11.3.6 Information of technical works related to certain use cases or applications

(1). Deployment Strategies for Ultra-Reliable and Low-Latency Communication in Factory Automation [65]

[As conclusions of a study of deployment strategies for ultra-reliable and low-latency communication in factory automation, with a proper physical layer design exploiting diversity gain, it is possible to guarantee ultra-reliable communications with extreme low-latency down to the sub-millisecond. With such a design, full coverage can be provided for a 300 m x 300 m factory floor. For larger factory halls, where more base stations need to be deployed, interference becomes a limiting factor with reuse-1. Simulations have shown that if it is possible to keep the deployments under control, partial frequency reuse or frequency separated system can be more spectral efficient as it requires less bandwidth than a system in which the same frequency channels are fully reused among neighboring BS's.

Capacity evaluations have shown that it is possible to serve nearly 20 K devices with a reasonable antenna configuration and a bandwidth allocation. The system capacity is mainly affected by the diversity and the system bandwidth.

Furthermore, interference management techniques (e.g., ICI coordination) could be used to improve the system availability in terms of coverage and capacity.]

- The technology would be useful when applied to : [mMTC]
- Expected performance/features when applied:
[Capacity evaluations have shown that it is possible to serve nearly 20 K devices with a reasonable antenna configuration and a bandwidth allocation.]
- Preconditions when applied:
[With a proper physical layer design exploiting diversity gain]

(2). Millimeter-wave (60-GHz band) High-Speed Close Proximity Transmission Technology [66][67][68]

The Millimeter-wave High-Speed Close Proximity Transmission Technology uses wireless communications over a 60 GHz unlicensed band to enable instantaneous

high-volume content transfer.

- Point-to-Point connection over millimeter-wave (60 GHz) band. Enable Point-to-Point high-speed wireless communication without interference from surrounding traffic.
- Close proximity (less than 10cm) data transfer. Prevents information leakage by close proximity transmission.
- The technology would be useful when applied to : [mMTC]

A user can instantaneously download large-volume files such as movies, music and photos when the user touches their mobile device to the HRCP (high-rate close proximity) access point which is implemented on e.g., automatic ticket gates,

- Expected performance/features when applied:

When the transmission rate is 2 Gbit/s, downloading time for a 30-minutes video file whose size is 50 MBytes will be 220 msec.

-Mitigates the wireless traffic loads in 5G mobile networks, by downloading large-volume files at these HRCP access points.

-Reduces power consumption in mobile device, because wireless communication is not required while playing video, unlike streaming usage.

- Preconditions when applied:

(1) high-rate multi-Gbit/s wireless transmission, (2) device management functions that turns on the wireless module only during the downloading, and (3) cache mechanisms for delivering the content file to HRCP access point at which the download will occur.

- Radio access technologies using unlicensed bands will be employed for (1).
- To realize (2) and (3), new management/ control functions that interoperate with 5G mobile networks are needed.

11.3.7 Information of technical works related to energy saving nature

(1). Millimeter-wave (60-GHz band) High-Speed Close Proximity Transmission Technology [66][67][68]

The Millimeter-wave High-Speed Close Proximity Transmission Technology uses wireless communications over a 60 GHz unlicensed band to enable instantaneous high-volume content transfer.

- Point-to-Point connection over millimeter-wave (60 GHz) band. Enable Point-to-Point high-speed wireless communication without interference from surrounding traffic.
- Close proximity (less than 10cm) data transfer. Prevents information leakage by

close proximity transmission.

- The technology would be useful when applied to : [mMTC]

A user can instantaneously download large-volume files such as movies, music and photos when the user touches the mobile device to the HRCP (high-rate close proximity) access point which is implemented on e.g., automatic ticket gates.

- Expected performance/features when applied:

When the transmission rate is 2 Gbit/s, downloading time for a 30-minutes video file whose size is 50 MBytes will be 220 msec.

-Mitigates the wireless traffic loads in 5G mobile networks, by downloading large-volume files at these HRCP access points.

-Reduces power consumption in mobile device, because wireless communication is not required while playing video, unlike streaming usage.

- Preconditions when applied:

(1) high-rate multi-Gbit/s wireless transmission, (2) device management functions that turns on the wireless module only during the downloading, and (3) cache mechanisms for delivering the content file to HRCP access point at which the download will occur.

- Radio access technologies using unlicensed bands will be employed for (1).

- To realize (2) and (3), new management/ control functions that interoperate with 5G mobile networks are needed.

(2). Energy Performance of 5G-NX Wireless Access Utilizing Massive Beamforming and an Ultra-lean System Design [69][70]

[The energy performance of 5GNX systems, characterized by ultra-lean design and massive beamforming, is estimated for a dense urban (major Asian city) scenario with novel power consumption models where sleep power is defined based on the maximum allowed DTX periods by each system. The results show that 5G-NX systems provide much better energy performance compared to LTE due to the ultra-lean design and the high beamforming gain, enabling longer and more efficient sleep. At expected traffic levels beyond 2020, 5G-NX is shown to decrease the energy consumption by more than 50% while providing around 10 times more capacity.

Furthermore, carrier aggregation was shown to be a promising solution that combines the benefit from higher bandwidth and beamforming capabilities at 15 GHz, and the better propagation conditions at 2.6 GHz. As a result, at expected traffic levels beyond 2020, carrier aggregation with 5G-NX provides superior performance with lower energy consumption despite the comparably energy inefficient LTE layer.

The main focus of future work will be to evaluate the energy saving potential of 5G-NX at country level considering more scenarios, alternative deployments and operating frequencies...]

- The technology would be useful when applied to : [eMBB, mMTC]
- Expected performance/ features when applied:
[Decrease the energy consumption by more than 50% while providing around 10 times more capacity compared with existing LTE].
- Preconditions when applied:
[To be confirmed]

11.3.8 Information of technical works related to RAN virtualization

(1). RAN Virtualization [71][72][73] [74][75]

Novel heterogeneous networks can be realized by radio access network (RAN) virtualization and softwarization in the 5G mobile network. The RAN virtualization is an effective approach in a fabric of Cloud-RAN structure for example, since the mobile network needs to support flexible capabilities in terms of frequency bands, transmission schemes, antenna configuration, multiplex access attributes, etc.

Given the technical trends above, future RAN may have a capability of intelligent control on radio configurations, front/back-haul transmissions, and radio resources of a number of small cells which are organized virtually from the central controller.

A concept of RAN virtualization is illustrated in Figure 10 of Ref. [71]. In this example, several slices are configured in association with the service profile to achieve the required quality and reliability by radio network arrangement with RATs, bandwidth, antenna configuration, transmission power, latency, mobility, and so on.

- The technology would be useful when applied to : eMBB, URLLC, mMTC:

In the future, more diverse services will come out in various usage scenarios in some working environments with wide ranges of data rate, latency, connection density, data size, mobility, reliability, etc. for the associated service profiles.

Flexible programming on the softwarized virtualization can help handling those service data transmissions under the virtual control function. It will be beneficial to the network operators, service providers and end users.

- Expected performance/ features when applied:
RAN virtualization can support following radio network capabilities:
- RAN controller integrates overall network control, scheduling, and data transport control throughout the user devices, remote radio unit (RRU), radio access schemes, fronthaul, backhaul, and radio resources such as transport bandwidth, RAT

attributes, signaling on BBU.

- Upper controller of cloud network can potentially cover the RAN in the end-to-end network coordination.
- Depending on the requirements for service application, the network slices are flexibly arranged and scaled up or down in a configuration set with appropriate network resources, virtual network functionalities (VNFs) in the virtual network topology in dynamic way.
- The RAN has a capability of orchestrating the VNF chain by arranging and scheduling the virtual machines, storage memories, processing units, and so on. In consequence, all the data processing functions and the transport lines become programmable in software.
- Network resources can be flexibly allocated in a scalable manner under the RAN controller. Network resources are pooled, and idle resources can be shared among some network slices.
- As a result of the expected capabilities as above, the network can provide comfortable quality of experience (QoE) for a variety of services in a reasonable cost (CAPEX and OPEX) with higher flexibility and agility.
- Preconditions when applied:

In a case of cloud-RAN model, it generally consists of RAN control platform, BBU pools, backhaul connection to core network, Fronthaul connection to a number of small cell sites for remote radio units (RRU). In a 5G novel network, the RAN is expected to have an intelligent control over functions and transport network in a virtual network structure, and a number of small cell sites with various radio network resources which can be controlled remotely from the central controller.

11.3.9 Other information of technical works related to ‘5G’ RAN

Additional ‘5G’ related technical works have been identified. These are microwave backhaul with multiband [76] and a white paper summarizing ‘5G’ RAN related work as a white paper [77].

References

- [1] “Mobile Communications Systems for 2020 and beyond,” ARIB 2020 and Beyond Ad Hoc Group White Paper, Oct.2014.
- [2] Genichiro Ohta and Takuro Sato, “An Orthogonal Frequency Multiplexed (OFDM) four-layer SSB-QAM Modulation method,” IEICE RCS report, vol. 114, no. 490, RCS2014-328, pp. 159-164, March 2015.
- [3] Genichiro Ohta and Takuro Sato, “ A Study of Four-layered SSB-QAM Modulation Method (Part

- 2) ,“IEICE RCS report, vol. 114, no. 30, RCS2014-31, pp. 67-72, May 2014.
- [4] Genichiro Ohta and Takuro Sato, “A Study of Multi-level modulation for SSB-QPSK method, “IEICE RCS report, vol. 113, no. 456, RCS2013-312, pp. 37-42, March 2014.
- [5] Yi Jiang, Zhenyu Zhou, Masahiko Nanri, Genichiro Ohta and Takuro Sato, “Performance Evaluation of Four Orthogonal Single Sideband Elements Modulation Scheme in Multi-Carrier Transmission Systems”, Vehicular Technology Conference (VTC Fall), 2011 IEEE.
- [6] G.Ohta, M. Uesugi, T. Sato and H. Tominaga, “Considerations on New Modulation Methods for Mobile-Multimedia Wireless”, IEICE TRANSACTIONS on Fundamentals of Electronics, Communications and Computer Sciences Vol.E87-A No.10 pp.2676-2683, Oct. 2004.
- [7] G. Berardinelli, et. al. “On the potential of zero-tail DFT-spread-OFDM in 5G networks”, 2014 IEEE 80th Vehicular Technology Conference (VTC Fall), 2014.
- [8] F. Hasegawa, et. al., "Static sequence assisted out-of-band power suppression for DFT-s-OFDM," in Personal, Indoor, and Mobile Radio Communications (PIMRC), 2015 IEEE 26th Annual International Symposium on , vol., no., pp.61-66, Aug. 30 2015-Sept. 2 2015.
- [9] Yuya Saito, et al., “Field Experimental Trial of Filtered-OFDM for Uplink Transmission”, IEICE General Conf., Mar. 2016
- [10] Huawei Whitepaper, “5G: New Air Interface and Radio Access Virtualization”, April 2015
- [11] Javad Abdoli, M. Jia and J. Ma, “Filtered OFDM: A New Waveform for Future Wireless Systems”, IEEE SPAWC2015, pp. 66 - 70, 2015.
- [12] Peiying Zhu, “5G Enabling Technologies – An Unified Adaptive Software Defined Air Interface”, Sept 3rd, 2014, PIMRC.
- [13] Huawei Whitepaper, “5G: New Air Interface and Radio Access Virtualization”, April 2015.
- [14] Huawei Technologies, “Vision on 5G Radio Access Technologies”, RWS-150006, page.14, 3GPP RAN workshop on 5G, Sept.17-18, 2015.
- [15] Bin Li, Hui Shen, David Tse, "An Adaptive Successive Cancellation List Decoder for Polar Codes with Cyclic Redundancy Check", IEEE Communications Letters, Vol.16, No.12, December 2012.
- [16] S. B. Korada, E. Sasoglu, and R. L. Urbanke, “Polar codes: characterization of exponent, bounds, and constructions,” IEEE Trans. Inf. Theory, vol. 56, pp. 6253–6264, 2010.
- [17] E. Arıkan and E. Telatar, “On the rate of channel polarization,” in Proc. 2009 IEEE Int’l Symp. Inform. Theory, pp. 1493–1495.
- [18] I. Tal and A. Vardy, “How to construct polar codes,” in Proc. 2010 IEEE Inform. Theory Workshop.
- [19] I. Tal and A. Vardy, “List Decoding of Polar Codes,” available as online as arXiv: 1206.0050v1.
- [20] E. Arıkan, “Polar Coding: Status and Prospects”, Plenary Talk of IEEE International Symposium on Inform. Theory, Saint Petersburg, Russia, 2011.
- [21] S. B. Korada, E. Sasoglu, and R. L. Urbanke, “Polar codes: Characterization of exponent, bounds, and constructions,” IEEE Trans. Inform. Theory, vol.56, pp. 6253–6264, 2010.
- [22] E. Arıkan and E. Telatar, “On the rate of channel polarization,” in Proc.IEEE Int’l Symp. Inform. Theory, Seoul, South Korea, 2009, pp.1493–1495.
- [23] I. Tal and A. Vardy, “How to construct polar codes,” in Proc. IEEE Inform. Theory Workshop, Dublin, Ireland, 2010.
- [24] P. Trifonov, “Efficient Design and Decoding of Polar Codes,” IEEE Trans. Commun., vol. 60, no. 11, pp. 3221-3227, Nov. 2012.
- [25] B. Li, H. Shen, and D. Tse, “An Adaptive Successive Cancellation List Decoder for Polar Codes with Cyclic Redundancy Check,” IEEE Comm. Letters, vol. 16, pp. 2044–2047, Dec. 2012.
- [26] C. Leroux, I. Tal, A. Vardy, and W. J. Gross, “Hardware Architectures for Successive Cancellation Decoding of Polar Codes”, IEEE ICASSP, 2011.
- [27] C. Zhang, B. Yuan, and K. K. Parhi, “Reduced-latency SC polar decoder architectures,” ICC 2012, pp. 3471 - 3475.
- [28] Bin Li, Hui Shen, and David Tse, “Parallel Decoders of Polar Codes”.
- [29] Liang Zhang, Zhaoyang Zhangy, Xianbin Wang, Qilian Yu, Yan Chen, "On the Puncturing Patterns for Punctured Polar Codes", 2014 IEEE International Symposium on Information Theory, pp.125-125.
- [30] Huawei Whitepaper, “5G: New Air Interface and Radio Access Virtualization”, April 2015.
- [31] Huawei Technologies, “Vision on 5G Radio Access Technologies”, RWS-150006, p.12, 3GPP RAN workshop on 5G, Sept. 17-18, 2015.
- [32] Peiying Zhu, “5G Enabling Technologies – An Unified Adaptive Software Defined Air Interface”, p.7-10, Sept

- 3rd, 2014, PIMRC.
- [33] Report ITU-R M.2320-0 (11/2014), "Future technology trends of terrestrial IMT systems", 5.1.1.2 Non-orthogonal multiple access.
- [34] Hosein Nikopour and Hadi Baligh, "Sparse Code Multiple Access", 2013 IEEE 24th Annual International Symposium on Personal, Indoor, and Mobile Radio Communication (PIMRC), pp.327-331.
- [35] Alireza Bayesteh, "Blind Detection of SCMA for Uplink Grant-Free Multiple-Access", IEEE pp. 853-857, 2014.
- [36] Mahmoud Taherzadeh, et al., "SCMA Codebook Design", IEEE VTC-fall, Vancouver 2014.
- [37] Kelvin Au, et al., "Uplink Contention Based SCMA for 5G Radio Access", Globecom 2014 Workshop - Emerging Technologies for 5G Wireless Cellular Networks, pp.900-905.
- [38] Hosein Nikopour, et al., "SCMA for Downlink Multiple Access of 5G Wireless Networks", IEEE pp. 3840-3844, 2014.
- [39] METIS Deliverable D2.2, "Novel radio link concepts and state of the art analysis" Version 1, 31-10-13, p.42-46.
- [40] METIS Deliverable D2.3, "Components of a new air interface - building blocks and performance" Version 1, METIS, 30/04/2014, p.41-42, p.90.
- [41] METIS Deliverable D2.4, "Proposed solutions for new radio access", Version 1, 28/02/2015, p.152-160.
- [42] METIS Deliverable D4.3, "Final Report on Network-Level Solutions", Version 1, 01/03/2015, p.13-102.
- [43] METIS Deliverable D6.5, "Report on simulation results and evaluations", Version 1, 01/03/2015, p.5-.
- [44] METIS Deliverable D8.4, "METIS final project report", Version 1, 30/04/2015, p.14-19.
- [45] Y. Hamaguchi, et al., "Activities on technologies of massive devices and low latency communication toward 5G," IEICE Technical Report, RCS2015-184, pp. 141-145, Oct. 2015.
- [46] NGMN Final Deliverable, "NGMN 5G WHITE PAPER," Version 1.0, 17/02/2015, p.88.
- [47] W.Wang and X. Wang, "Virtual Full Duplex via Joint Selection of Transmission Point and DL/UL Configuration," VTC spring 2015.
- [48] H. Nishimoto, H. Iura, A. Taira, A. Okazaki, and A. Okamura, "Block lower multi-diagonalization for multiuser MIMO downlink," Proc. WCNC2016 Workshop, pp. 342--347, Qatar, April 2016.
- [49] H. Nishimoto, A. Taira, H. Iura, S. Uchida, A. Okazaki, and A. Okamura, "A study on Nonlinear Block Multi-diagonalization Precoding for High SHF Wide-band Massive MIMO in 5G,". IEICE Tech. Report, RCS2016-377, pp. 255--260, March 2016. (in Japanese)
- [50] A. Benjebbour, et al., "Experimental Trial of TDD Downlink Massive MIMO", IEICE General Conf., Mar. 2016.
- [51] X. Wang, et al., "Experimental Trial of Downlink Massive MU-MIMO with Non-linear Precoding", IEICE General Conf., Mar. 2016.
- [52] Press release, "Huawei to bring 73GHz mmWave Mu-MIMO live demo to Deutsche Telekom", 2016-02-18, <http://www.huawei.com/en/news/2016/2/73GHzmm-Wave-Mu-MIM-live-demo>.
- [53] W.Roh et al., "Millimeter-Wave Beamforming as an Enabling Technology for 5G Cellular Communications: Theoretical Feasibility and Prototype Results," IEEE Commun. Mag., vol.52, no.2, Feb.2014.
- [54] A.Taira et al., "Performance Evaluation of 44GHz Band Massive MIMO Based on Channel Measurement," IEEE Globecom Workshops (GC Wkshps), Dec. 2015.
- [55] T.Obara et al., "Channel Estimation for Super High Bit Rate Massive MIMO Systems Using Joint Processing of Analog Fixed Beamforming and CSI-based Precoding", IEEE CSCN2015, Oct.2015.
- [56] M.Shimizu, Y.Ohashi and M.Yoshida, "Millimeter-wave Beam Multiplexing Method Using a Hybrid Beamforming," IEICE Technical Report, SRW2015073, Mar. 2016. (in Japanese)
- [57] "5G Radio Access Technologies and Our Activity – Massive MIMO and Beam Control", IEICE General Conference2016, BP-1-5. (In Japanese)
- [58] S. Umeda, A. Okazaki, H. Nishimoto, K. Tsukamoto, K. Yamaguchi, and A. Okamura, "Cell structure for high-speed land-mobile communications," Proc. IEEE VTC2015-Fall, Sept. 2015.
- [59] H. Nishimoto, A. Okazaki, Y. Kinoshita, K. Tsukamoto, S. Umeda, K. Tsuji, K. Yamaguchi, and A. Okamura, "Millimeter-wave train radio communication system based on linear cell concept," Proc. STECH2015, Nov. 2015.
- [60] N. Gresset, H. Bonneville, "Fair preemption for joint delay constrained and best effort traffic scheduling in wireless networks," Net4cars/Net4trains, 8th International Workshop on Communication Technologies for Vehicles, Sousse, Tunisia, May 2015.
- [61] M.Minowa, H.Seki, Y.Okumura, S.Suyama, A.Otaka, S.Kimura, M.Nakatsuwgawa, H.Asano, Y.Ichikawa,

- Y.Hirano, Y.Yamao, F.Adachi and M.Nakazawa, “[] Invited Lecture] 5G R&D Activities for High Capacity Technologies with Ultra High-Density Multi-Band and Multi-Access Layered Cells,” IEICE Technical report, RCS2015-250, Dec. 2015. (in Japanese)
- [62] Riichi Kudo, B. A. Hirantha Sithira Abeysekera, Yasushi Takatori, Takeo Ichikawa, Masato Mizoguchi, Hiroto Yasuda, Akira Yamada, and Yukihiro Okumura, “Channel Access Acquisition Mechanism Coupled with Cellular Network for Unlicensed Spectrum,” in Proc., IEEE VTC2015Spring, May 2015.
- [63] Riichi Kudo, B. A. Hirantha Sithira Abeysekera, Yusuke Asai, Takeo Ichikawa, Yasushi Takatori, Masato Mizoguchi, “User equipment centric downlink access in unlicensed spectrum for heterogeneous mobile network,” IEICE Trans. on commun., vol.E98-B No.10, Oct. 2015.
- [64] Riichi Kudo, Yasushi Takatori, B. A. Hirantha Sithira Abeysekera, Yasuhiko Inoue, Atsushi Murase, Akira Yamada, Hiroto Yasuda, and Yukihiro Okumura, “Advanced Wi-Fi data service platform coupled with cellular network for future wireless access,” IEEE Commun. Mag., vol. 52, issue. 11, pp. 46-53, Nov. 2014.
- [65] Nadia Brahmī, Osman N. C. Yilmaz, Ke Wang Helmersson, Shehzad A. Ashraf, Johan Torsner, “Deployment Strategies for Ultra-Reliable and Low-Latency Communication in Factory Automation” ,International Workshop on Ultra-Low Latency and Ultra-High Reliability in Wireless Communications, Dec., 2015
- [66] Tadao Nakagawa, Hideki Toshinaga, Toshimitsu Tsubaki, Tomohiro Seki, and Masashi Shimizu, "Millimeter-wave close proximity high-speed data transfer system", IEICE Communications Express, Vol.5, No.4, pp.114-117, 2016.
- [67] Andrew Estrada, et al., “TG3e Technical Guidance Document”, IEEE 802.15 Doc. 15/0109r7, July, 2015.
- [68] Tadao Nakagawa, Hideki Toshinaga, Toshimitsu Tsubaki, Tomohiro Seki, Ken Hiraga, Masashi Shimizu, “Research on a Millimeter-Wave Close Proximity High-Speed Data Transfer System”, Thailand-Japan microwave workshop 2015 (TJMW2015), SA2-03, August, 2015.
- [69] Sibel Tombaz, Pål Frenger, Fredrik Athley, Eliane Semaan, Claes Tidestav and Anders Furuskär, “Energy Performance of 5G-NX Wireless Access Utilizing Massive Beamforming and an Ultra-lean System Design”, IEEE Global Communications Conference (GLOBECOM’15), Dec., 2015
- [70] “5G energy performance”, Ericsson white paper, Apr. 2015.
- [71] ITU-T, FG IMT-2020, “FG IMT-2020: Report on Standards Gap Analysis”, TD208-PLN/13, Nov.16, 2015, p.96-99.
- [72] Peter Ashwood-Smith, “5G and the Wireline Network”, FOE-4, April, 2016.
- [73] Report ITU-R M.2320-0 (11/2014), “Future technology trends of terrestrial IMT systems”, 5.6.4 Cloud-RAN.
- [74] NGMN, “SUGGESTIONS ON POTENTIAL SOLUTIONS TO C-RAN BY NGMN ALLIANCE”, DATE: 03-JANUARY-2013, VERSION 4.0.
- [75] China Mobile Research Institute, “C-RAN, The Road Towards Green RAN (Version 3.0)”, White Paper, Version 3.0 (Dec, 2013).
- [76] “Microwave backhaul gets a boost with multiband,” Ericsson Technology Review, Vol.93, 2016.
- [77] “5G radio access,” Ericsson white paper, Apr. 2016.